



Ku-Band MMIC VCO with DIVIDE-BY-8, 13.2 - 13.5 GHz

Typical Applications

Low noise MMIC VCO w/Divide-by-8 for Ku-Band applications such as:

- Point-to-Point Radios
- Point-to-Multi-Point Radios / LMDS
- VSAT

Features

- Pout: -7 dBm
- Phase Noise: -105 dBc/Hz @100 KHz Typ.
- No External Resonator Needed
- Single Supply: 5V @ 290 mA
- QSOP16G SMT Package

Functional Diagram

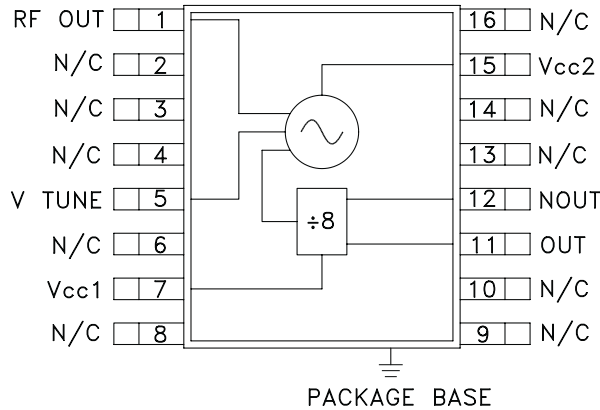

General Description

The HMC401QS16G & HMC401QS16GE are GaAs InGaP Heterojunction Bipolar Transistor (HBT) MMIC VCOs. The HMC401QS16G & HMC401QS16GE integrate resonators, negative resistance devices, varactor diodes and divide-by-8 prescalers. The VCO's phase noise performance is excellent over temperature, shock, and process due to the oscillator's monolithic structure. Power output is -7 dBm typical from a 5V supply voltage. The voltage controlled oscillator is packaged in a low cost, surface mount 16 leaded QSOP package with an exposed base for improved RF and thermal performance.

Electrical Specifications, $T_A = +25^\circ C$, V_{cc1} , $V_{cc2} = +5V$

Parameter	Min.	Typ.	Max.	Units
Frequency Range	13.2 - 13.5			GHz
Power Output	FR Output	-10	-7	dBm
	Divided Output	-9	-6	dBm
SSB Phase Noise @ 100 kHz Offset, $V_{tune} = +5V$ @ RF Output		-105		dBc/Hz
Tune Voltage	V_{tune}	0	10	V
Supply Current	I_{cc1} (Digital)	65		mA
	I_{cc2} (RF)	225		mA
Tune Port Leakage Current ($V_{tune} = 10V$)			10	μA
Output Return Loss		2		dB
Harmonics/Subharmonics	1/2	-7		dBc
	3/2	-28		dBc
	2nd	-17		dBc
	5/2	-40		dBc
Pulling (into a 2.0:1 VSWR)		0.6		MHz pp
Pushing @ $V_{tune} = 5V$		5		MHz/V
Frequency Drift Rate		1.5		MHz/ $^\circ C$



HMC401QS16G / 401QS16GE

Ku-Band MMIC VCO with DIVIDE-BY-8, 13.2 - 13.5 GHz

Frequency vs. Tuning Voltage, $T = 25^{\circ}\text{C}$

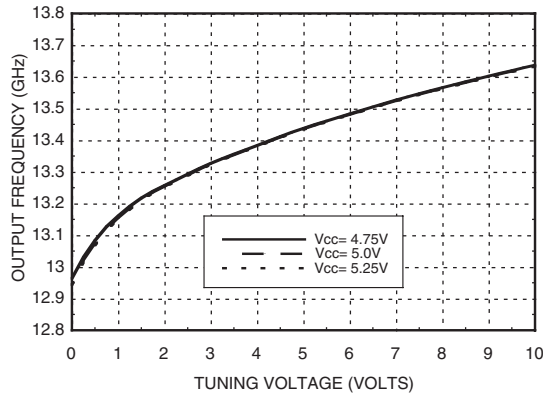

Frequency vs. Tuning Voltage, $V_{cc} = +5V$

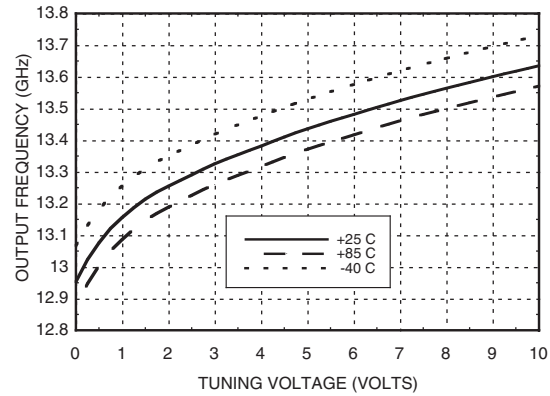

Sensitivity vs. Tuning Voltage, $V_{cc} = +5V$

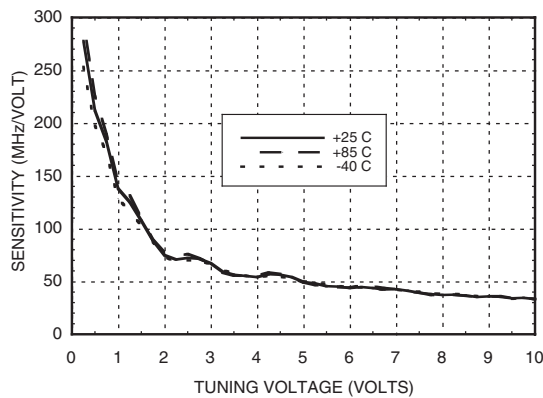

Output Power vs. Tuning Voltage, $V_{cc} = +5V$

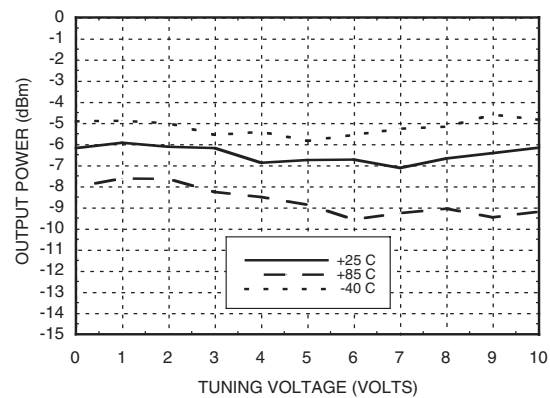

SSB Phase Noise vs. Tuning Voltage

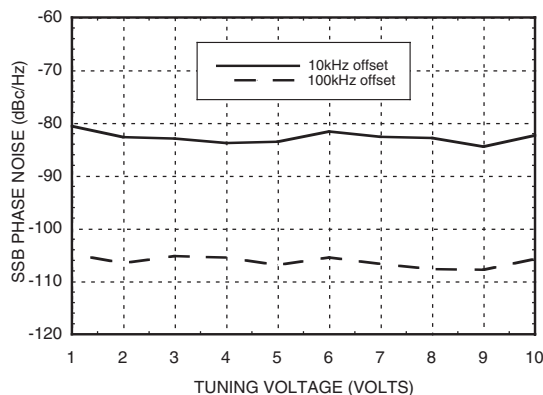

Phase Noise @ $V_{tune} = 5V$

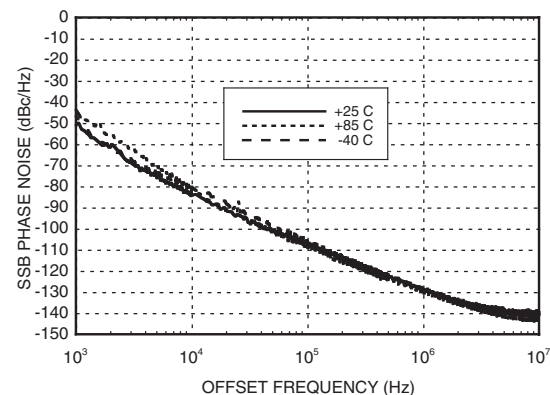



Ku-Band MMIC VCO with DIVIDE-BY-8, 13.2 - 13.5 GHz

**Divided Frequency
vs. Tuning Voltage, Vcc= +5V**

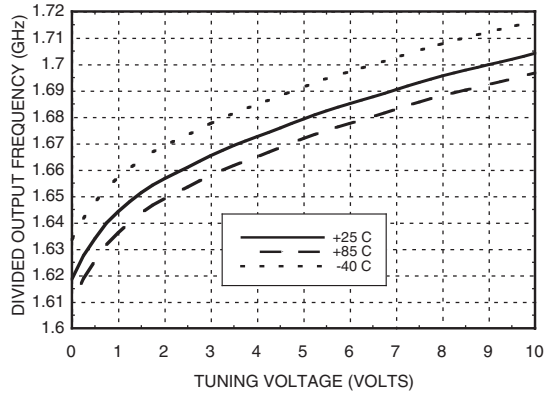

**Divided Output
Power vs. Tuning Voltage, Vcc= +5V**

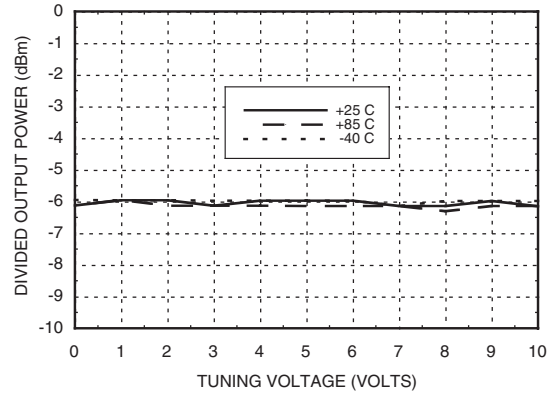

**Divided Output
SSB Phase Noise @ Vtune= 5V**

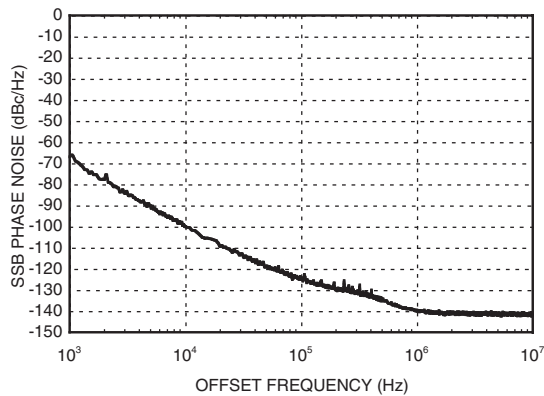

Absolute Maximum Ratings

Vcc1, Vcc2	5.5 V
Storage Temperature	-65 to +150 °C
Operating Temperature	-40 to +85 °C
Vtune	0 to 11V Max.
ESD Sensitivity (HBM)	Class 1A

Typical Supply Current vs. Vcc

Vcc (V)	Icc (mA)
4.75	260
5.0	290
5.25	315

Note: VCO will operate over full voltage range shown above.



ELECTROSTATIC SENSITIVE DEVICE
OBSERVE HANDLING PRECAUTIONS

Outline Drawing

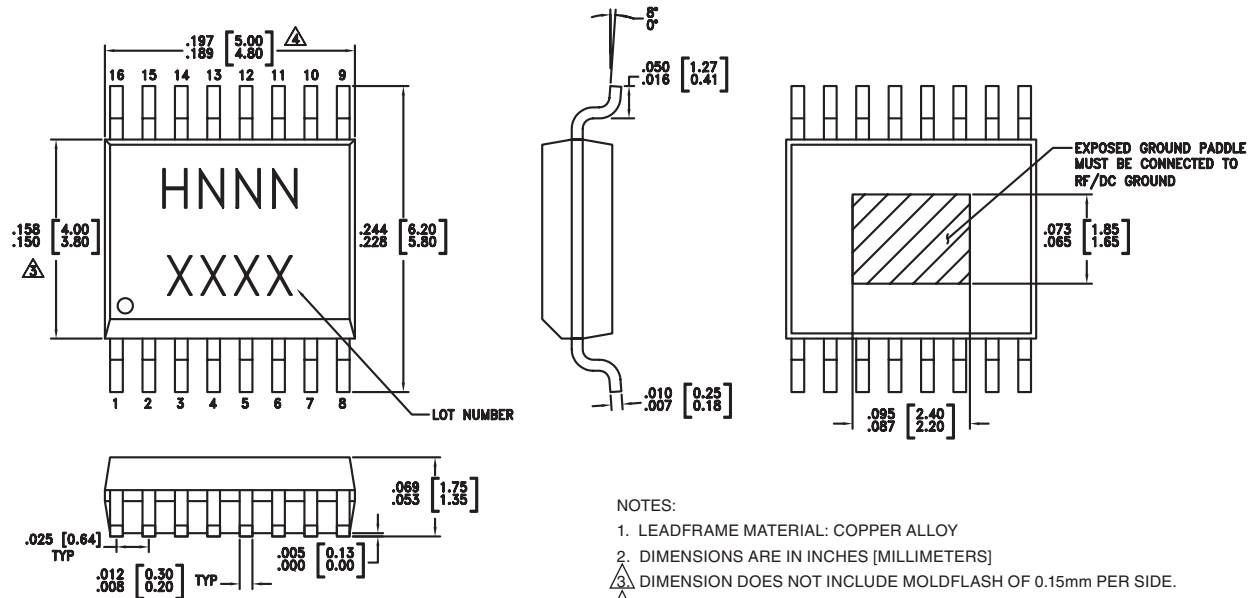

NOTES:

1. LEADFRAME MATERIAL: COPPER ALLOY
2. DIMENSIONS ARE IN INCHES [MILLIMETERS]
3. DIMENSION DOES NOT INCLUDE MOLDFLASH OF 0.15mm PER SIDE.
4. DIMENSION DOES NOT INCLUDE MOLDFLASH OF 0.25mm PER SIDE.
5. ALL GROUND LEADS AND GROUND PADDLE MUST BE SOLDERED TO PCB RF GROUND.

Package Information

Part Number	Package Body Material	Lead Finish	MSL Rating	Package Marking ^[3]
HMC401QS16G	Low Stress Injection Molded Plastic	Sn/Pb Solder	MSL1 ^[1]	H401 XXXX
HMC401QS16GE	RoHS-compliant Low Stress Injection Molded Plastic	100% matte Sn	MSL1 ^[2]	H401 XXXX



[1] Max peak reflow temperature of 235 °C

[2] Max peak reflow temperature of 260 °C

[3] 4-Digit lot number XXXX

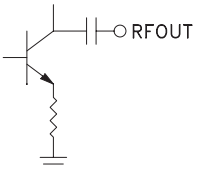
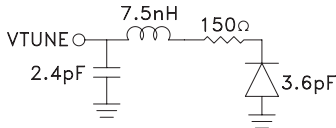
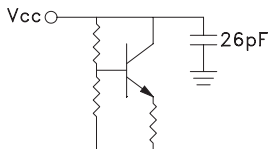
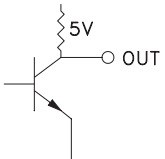
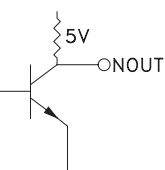

Pin Descriptions

Pin Number	Function	Description	Interface Schematic
1	RFOUT	RF output (AC coupled).	
2, 3, 4, 6, 8, 9, 10, 13, 14, 16	N/C	No Connection	
5	VTUNE	Control Voltage Input. Modulation port bandwidth dependent on drive source impedance.	
7, 15	VCC1, VCC2	Supply Voltage, 5V	
11	OUT	Divided Output	
12	NOUT	Divided Output 180° output phase with pin 11.	
	GND	Package bottom has an exposed metal paddle that must be RF & DC grounded.	

Evaluation PCB

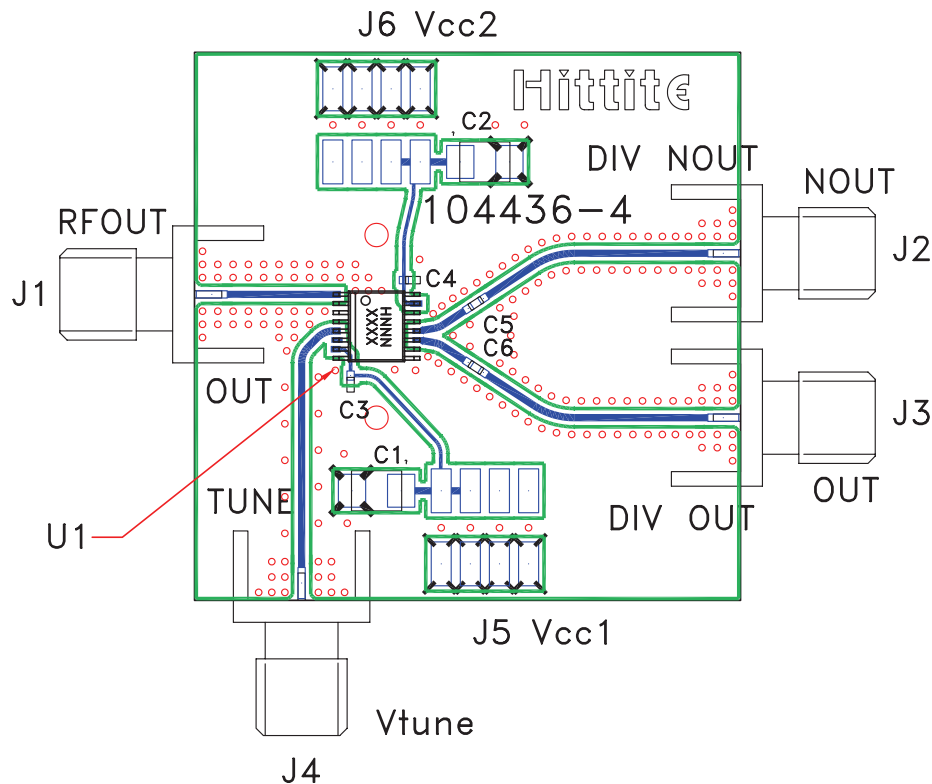

List of Materials for Evaluation PCB 104711 [1]

Item	Description
J1 - J4	PCB Mount SMA RF Connector
J5 - J6	2 mm DC Header
C1 - C2	10 μ F Tantalum Capacitor
C3 - C6	1,000 pF Capacitor, 0402 Pkg.
U1	HMC401QS16G / HMC401QS16GE VCO
PCB [2]	104436 Eval Board

[1] Reference this number when ordering complete evaluation PCB

[2] Circuit Board Material: Rogers 4350

The circuit board used in the final application should use RF circuit design techniques. Signal lines should have 50 ohm impedance while the package ground leads and backside ground slug should be connected directly to the ground plane similar to that shown. A sufficient number of via holes should be used to connect the top and bottom ground planes. The evaluation circuit board shown is available from Hittite upon request.

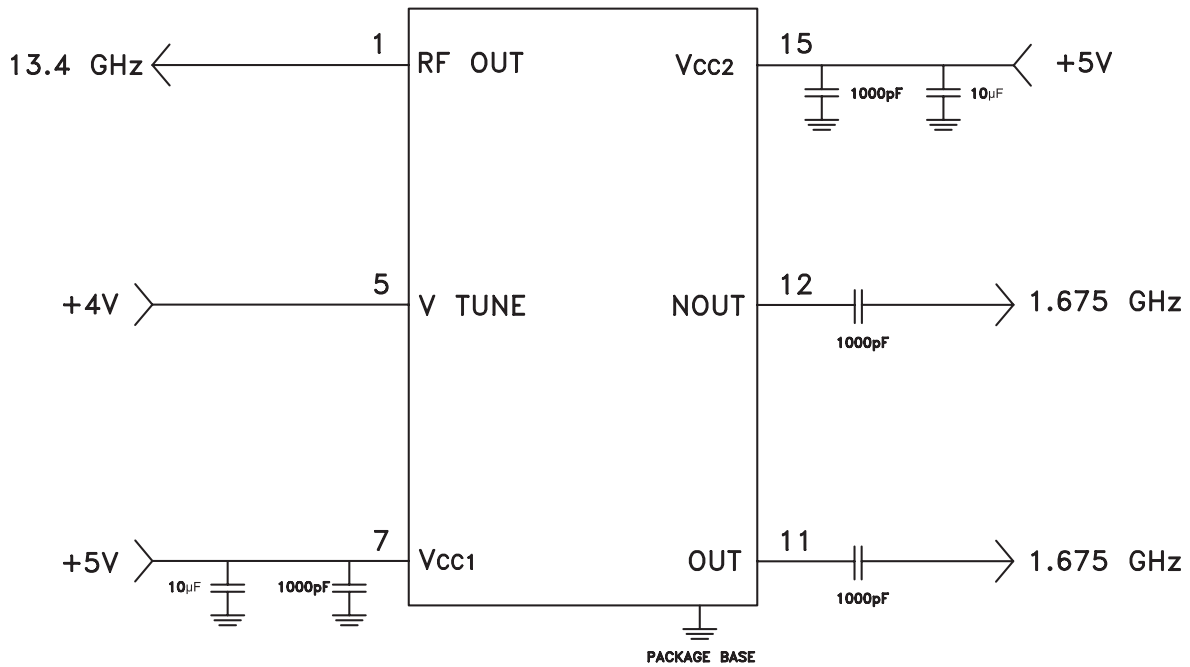
Typical Application Circuit



Notes: